

Model : SK-ST5Q48Vz-S

S TYPE 4 IN 1 5050RGBW 48LEDs/m DC12/24V





Product Features

- Flexible Zigzag Design
- Ideal for angles, curves & corner areas
- RGB/RGBW are available
- With genius 3M adhesive tape back, easy for installation



Structure & Parameter

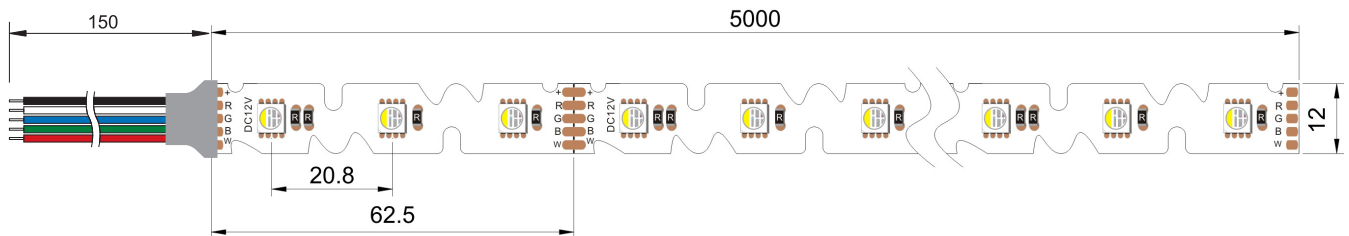

| | |
|---------------------|-----------------------|
| Input voltage | DC12V (24V available) |
| Power/m | 10W |
| Max current / LED | 50mA |
| Beam angle | 120 ° |
| LEDs /m | 48leds |
| SMD Type | 5050RGBW |
| Working hour | 30000h |
| Working temperature | -25 °C ~ +45 °C |
| Cutable length | 62.5mm |
| PCB Width | 12 |

CCT(K)

- R:620–630nm
- G:520–530nm
- B:465–475nm
- W:2700–6500K
- White can customized design

Lumen / m

- RGB Pure White: 880–920lm
- RGB Nature White: 850–880lm
- RGB Warm White: 750–850lm

Voltage & Current Curve

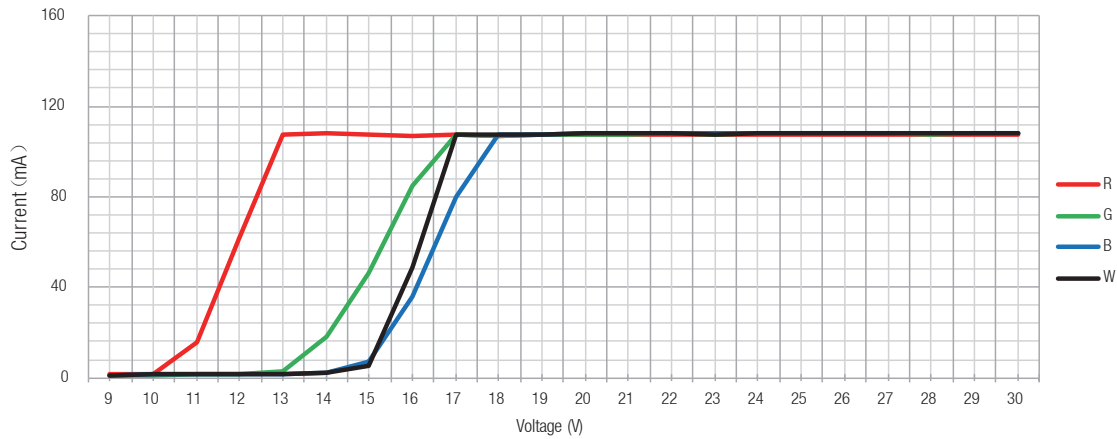

Note: This curve is tested when the IP20 1M LED Strip is under thermal stability after 2h continuous working in 15 C room temperature.

Temperature & Current Curve

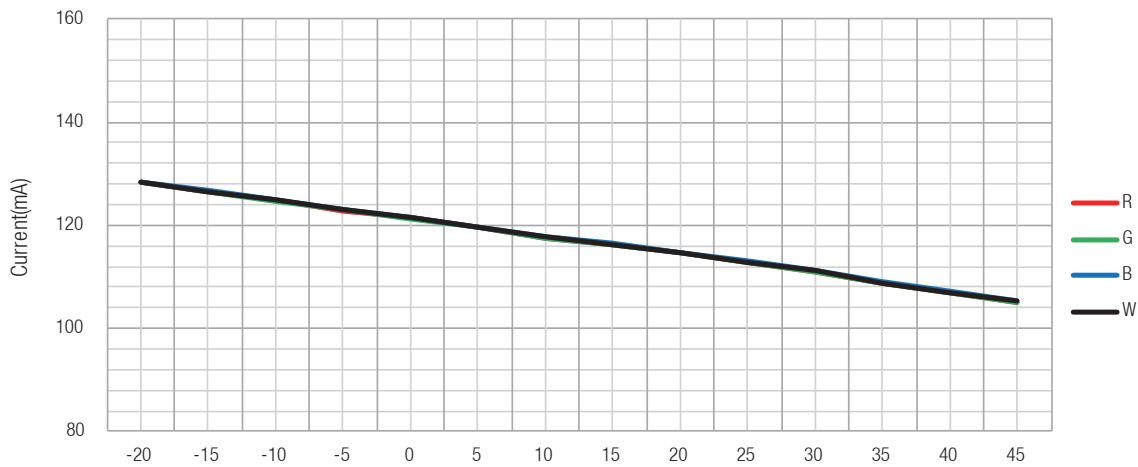

Note: This curve is test data of 1M LED Strip.

Light Distribution Curve

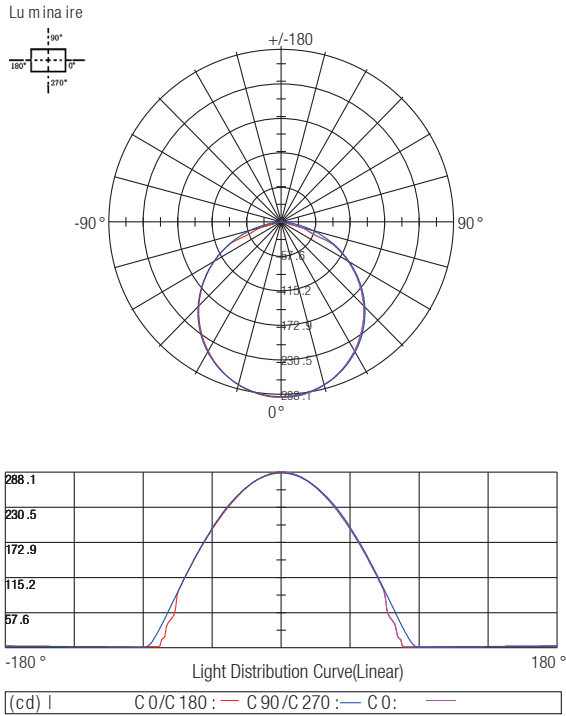

Lux-Distance Curve

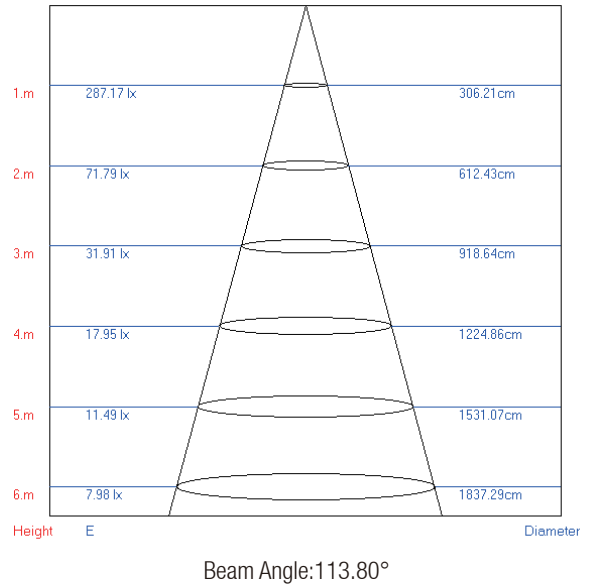

Wiring Diagram (1)

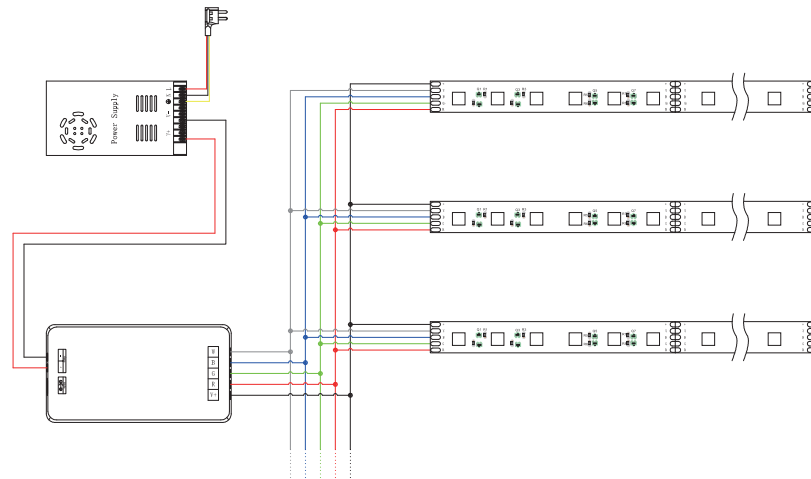

! Cautions

When install the led strip,please note the installation technique.The led strip can be bent,but not distorted,as shown below.

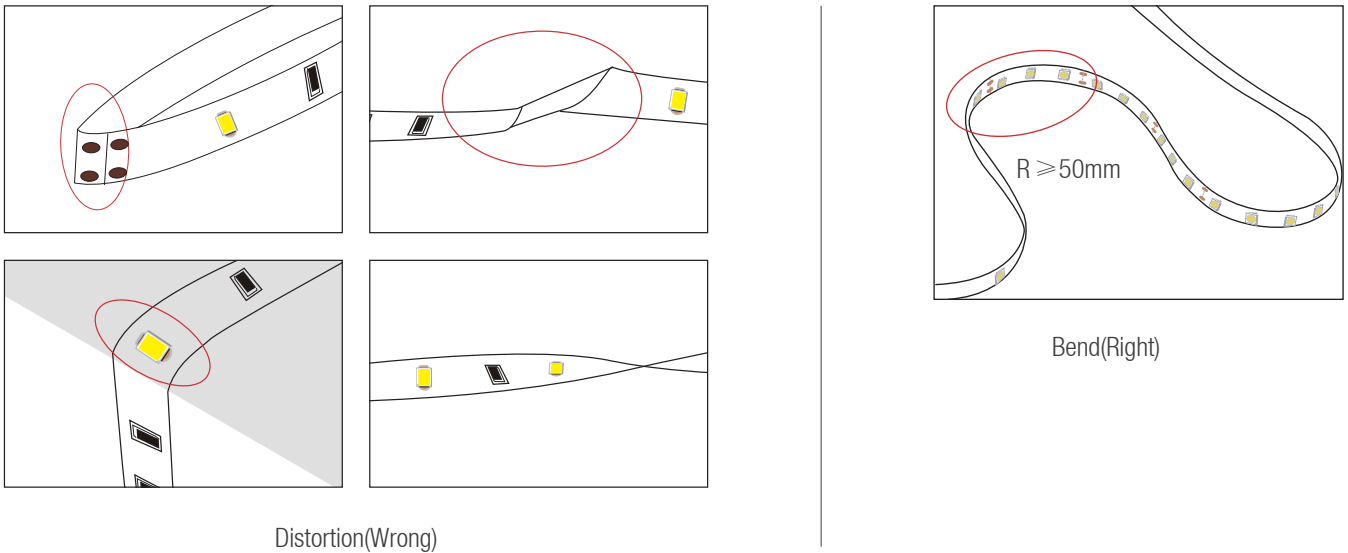

➤ LED strips are low voltage products,you must use the power supply(transformer).Please don,t connect the led strip directly to the AC 110v or AC 220v,otherwise it will burn out the LED strips.

➤ Clean up the installation surface,it will ensure the reliability of the adhesive,The electrical connection process must be operated by a professional person.

Package

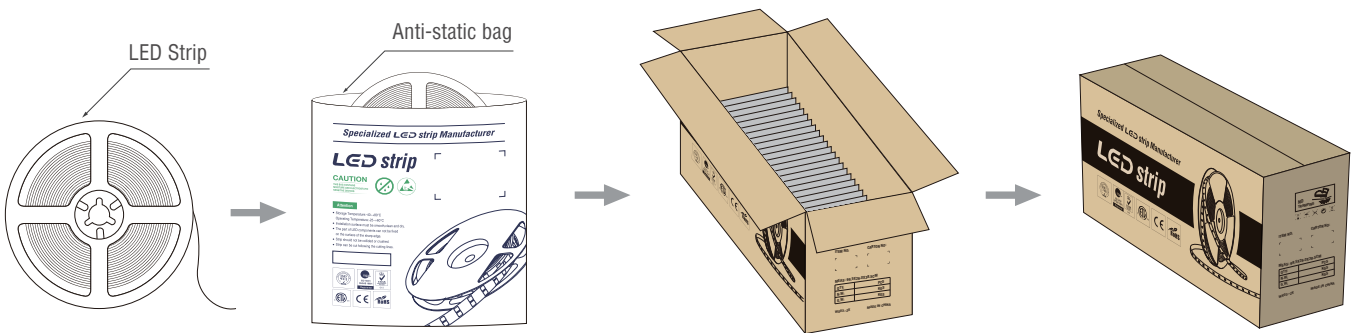

Certification

Certificate CN1730296

The management system of
SHENZHEN SHINESKY OPTOELECTRONICS CO., LTD.
2F, H1 Building, Hongfa Hi-tech Park, Tangtou, Shiyuan Town, Baoan District, Shenzhen, Guangdong, P.R. China
Unified Social Credit Code: 9144030761958133A

has been assessed and certified according to the requirements of
ISO 9001:2015

For the following activities:
Design and manufacture of LED strip products

Further certification regarding the scope of this certificate and the application of ISO 9001:2015 requirements may be obtained by contacting the organization.
This certificate is valid from 2 March 2017 until 1 March 2020 and remains valid subject to satisfactory surveillance audits.
Recertification audit due a minimum of 60 days before the expiration date.
Issued 1. Certified since 2 March 2017.

Authorized by:

SGS (United Kingdom) Ltd
150, Riverside Park, Bishops Cleeve, Chester, CH64 9TE, UK
E: uk@sgs.com, F: +44 (0)1244 373000, www.sgs.com
UKAS MANAGEMENT SYSTEMS
150 Riverside Park, Bishops Cleeve, Chester, CH64 9TE, UK
E: uk@sgs.com, F: +44 (0)1244 373000, www.sgs.com
Member of the Taylor's Group of Companies

SGS 9001 915 1915
Page 1 of 1

Intertek

AUTHORIZATION TO MARK

This authorizes the application of the Certification Mark(s) shown below to the models described in the Product(s) Covered section when made in accordance with the conditions set forth in the Certification Agreement and Listing Report. This authorization also applies to multiple latest model(s) identified on the continuation page of the Listing Report.
This document is the property of Intertek Testing Services and is not transferable. The certification mark(s) may be applied only at the location of the Party Authorized To Apply Mark.

| | |
|--|--|
| Applicant: Shenzhen Shinesky Optoelectronics Co., LTD | Manufacturer: Shenzhen Shinesky Optoelectronics Co., LTD |
| Address: 2F, H1 Building, Hongfa Hi-tech Park, Tangtou, Shiyuan Town, Baoan District, Shenzhen, Guangdong | Address: 2F, H1 Building, Hongfa Hi-tech Park, Tangtou, Shiyuan Town, Baoan District, Shenzhen, Guangdong |
| Country: China | Country: China |
| Contact: Bin Wu | Contact: Bin Wu |
| Phone: +86-755-26916255 | Phone: +86-755-26916255 |
| FAX: | FAX: |
| Email: mail@shsked.com | Email: mail@shsked.com |

Party Authorized To Apply Mark: Same as Manufacturer
Report Issuing Office: Intertek Testing Services Shanghai

Control Number: 5002906
Authorized by: Thomas J. [Signature]

This document supersedes all previous Authorizations to Mark for the noted Report Number.

Intertek Testing Services NA Inc.
440 East Algonquin Road, Arlington Heights, IL 60005
Telephone: 800-368-5813 or 847-439-8907 Fax: 847-439-8972

Standard(s): Low Voltage Lighting Systems - UL1218 (Issue: 2004/02/27 Ed: 1 Rev: 2014/02/24)
Standard(s): General Requirements for Luminaires - ICSA C22.2 No. 010 (Issue: 1999/05/01 Ed: 1 (R2011), with Gen. Inf. 1, 1997, Gen. Inf. 2, 1998)

Product: Low voltage lighting systems

Model(s): SK-S10VQV-2 (where "x", "y" and "z" is any number, "2" is a letter or the combination of a letter and a number)

ATM for Report 5002004691A-001
Page 1 of 1
ATM issued 21-May-2015

SGS

Verification Report No. CANEC170683702 Date: 17 May 2017 Page 1 of 14

SHENZHEN SHINESKY OPTOELECTRONICS CO., LTD
2F, H1 BUILDING HONGFA HI-TECH PARK, TANGTOU, SHIYUAN TOWN, BAOAN DISTRICT, SHENZHEN CITY 518108 P.R. CHINA

Sample Name: Flexible LED Strip
SGS Job No.: CP17-020413 - QZ

Internal Reference No.: 22
Tested Basic Model No.: SK-S730R012
(P.O. No.):
Tested Extended Model No. (P.O. No.): SK-S730R012, SK-S720R012, SK-S730V18

Client Ref. No.: See remark (4)

Date of Sample Received: 18 Apr 2017
Verification Period: 19 Apr 2017 - 17 May 2017

Verification Requested: With reference to RoHS Directive 2015/863/EU amending 2011/65/EC.
Verification Method: Please refer to next page(s).
Verification Result: Please refer to next page(s).

Verification Conclusion: Based on the verification results of the submitted samples, the results of Lead, Mercury, Cadmium, Hexavalent Chromium, Poly-aromatic hydrocarbons (PAHs), Poly(brominated diphenyl ethers) (PBDEs) do not exceed the limits as set by RoHS Directive (EU 2015/863 amending Annex II to Directive 2011/65/EC).
The test results are related only to the tested items. The report shall not be reproduced except in full without the written approval of the testing laboratory.

Note:

Signed for and on behalf of
SGS-CTC Standards Technical Services Co., Ltd. Guangzhou Branch

Jenny Liao
Approved Signatory

nqa global assurance

This is to certify that the Environmental Management System of

CLIENTS NAME SHINESKY OPTOELECTRONICS
ADDRESS 2F, H1 Building, Hongfa Hi-tech Park, Tangtou, Shiyuan Town, Baoan District, Shenzhen City 518108 P.R. China

applicable to
SCOPE
Flexible LED Strip

has been assessed and registered by NQA against the provisions of
ISO 14001:2004

This registration is subject to the company maintaining an environmental management system, to the above standard, which will be monitored by NQA. To maintain the validity of this certificate, the periodic surveillance shall be monitored by certification body. Please consult the website: www.nqa.com.cn

Certificate Number: 1805006
Date: 18 May 2017
Valid Until: 18 May 2020

Head of NQA
UKAS MANAGEMENT SYSTEMS
OTS

This is the ISO 14001 Accreditation Mark holder's confirmation in respect of their activities covered by the certification certificate under 01144761904.
Right to trading business: SHINESKY Optoelectronics Co., Ltd. Registered office: Baoan Town, Tangtou Hill Park, Hongfa Hi-Tech Park, Baoan District, Shenzhen, Guangdong, P.R. China.
The certificate is the property of NQA and shall not be re-used or copied.

nqa global assurance

This is to certify that the Environmental Management System of

CLIENTS NAME SHINESKY OPTOELECTRONICS
ADDRESS 2F, H1 Building, Hongfa Hi-tech Park, Tangtou, Shiyuan Town, Baoan District, Shenzhen City 518108 P.R. China

applicable to
SCOPE
Flexible LED Strip

has been assessed and registered by NQA against the provisions of
OHSAS 18001:2007

This registration is subject to the company maintaining an environmental management system, to the above standard, which will be monitored by NQA. To maintain the validity of this certificate, the periodic surveillance shall be monitored by certification body. Please consult the website: www.nqa.com.cn

Certificate Number: 1805006
Date: 18 May 2017
Valid Until: 18 May 2020

Head of NQA
UKAS MANAGEMENT SYSTEMS
OTS

This is the OHSAS 18001 Accreditation Mark holder's confirmation in respect of their activities covered by the certification certificate under 01144761904.
Right to trading business: SHINESKY Optoelectronics Co., Ltd. Registered office: Baoan Town, Tangtou Hill Park, Hongfa Hi-Tech Park, Baoan District, Shenzhen, Guangdong, P.R. China.
The certificate is the property of NQA and shall not be re-used or copied.

CERTIFICATE of Conformity
TÜV Rheinland

EC Council Directive 2014/30/EU Electromagnetic Compatibility

Registration No.: AE 50378145 0001
Report No.: 50080521 001

Holder: ShenZhen Shinesky Optoelectronics Co., LTD
2F, H1 Building, Hongfa Hi-tech Park, Tangtou, Shiyuan Town, Baoan District, Shenzhen City 518108 P.R. China

Product: LED lighting (Flexible LED Strip)

Identification: Type designation(s): SK-S730V1-2 (x, y, z are variables, refer to test report)
Serial No.: n/a
Remark(s): Refer to above-listed test report for details.

Tested acc. to: EN 60528:2013
EN 61347:2009

This certificate of conformity is based on an evaluation of a sample of the above mentioned product. Technical Report and documentation are at the License Holder's disposal. This is to certify that the tested sample is in conformity with all provisions of Annex B of Council Directive 2014/30/EU. This certificate does not imply assessment of the production of the product and does not prevent the use of a TÜV Rheinland mark of conformity. The holder of the certificate is authorized to use this certificate in connection with the EC declaration of conformity according to the a.m. Directive.

Date: 16.05.2017
TÜV Rheinland LGA Products GmbH - Tübingen - 90431 Nürnberg

CE The CE marking may only be used if all relevant and effective EC Directives are complied with. CE

S H I N E S K Y

**Specialized
LED strip
Manufacturer**

SHENZHEN SHINESKY OPTOELECTRONICS CO.,LTD



Building 29, Shancheng Industrial Park, Shiyan Street, Bao'an District,
Shenzhen, Guangdong, China.



OUR EMAIL

director@shineskygroup.com



OUR PHONE

Tel: 0755-29516255



OUR WEBSITE

Web: www.strip-lights.com