

SK-ST5Q60V24-Crgb

SMD5050 RGB 60 LEDs/m





Product Features

Mixing colors is much more beautiful. Single point of single control, high gray level, and can achieve a variety of beautiful effect. Its powerful lighting function to make it more valuable for different application areas.



Structure & Parameter

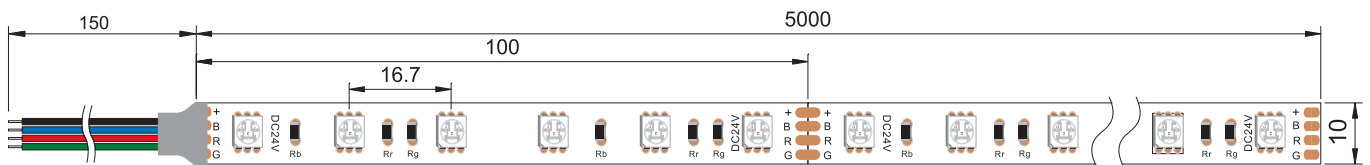

Optical Parameter

CCT(K)

- R:620–630nm
- G:520–530nm
- B:465–475nm

Basic Parameter

Lumen / m	388LM
Input voltage	DC24V (12V available)
Power/m	13w
Max current / LED	54mA
LEDs /m	60leds
SMD Type	5050RGB
Working hour	30000h
Working temperature	-25 °C ~+45 °C
Cutable length	100mm
PCB Width	10

Voltage & Current Curve

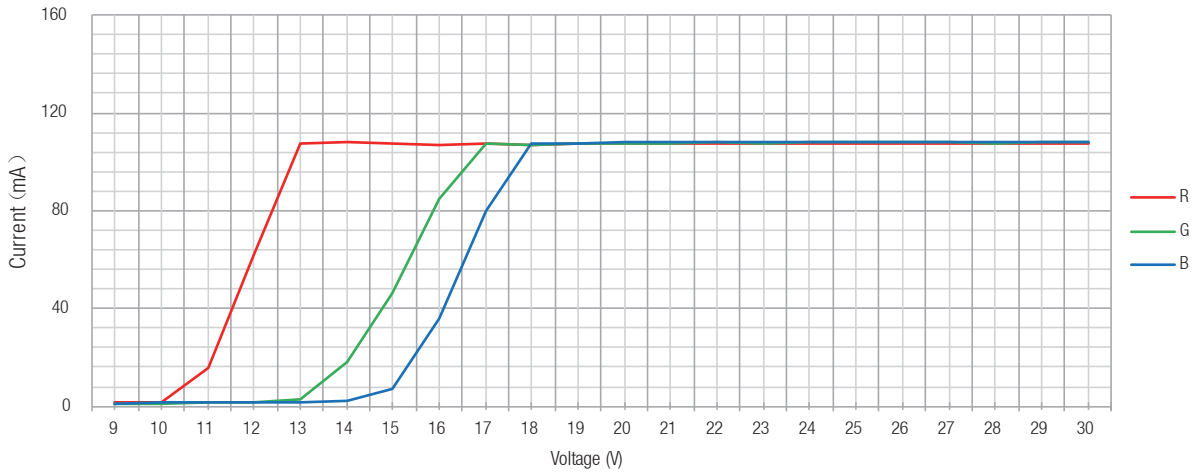

Note: This curve is tested when the IP20 1M LED Strip is under thermal stability after 2h continuous working in 15°C room temperature.

Temperature & Current Curve

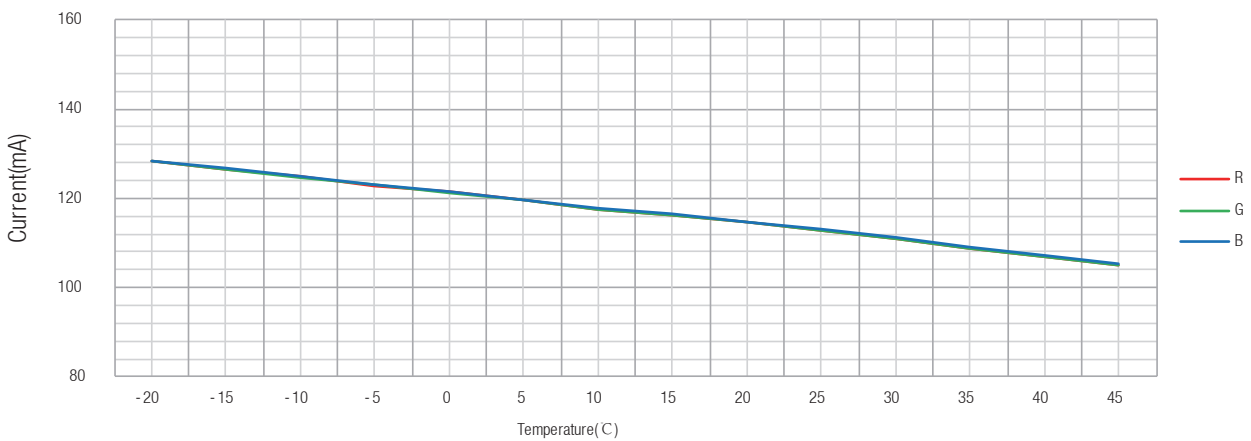

Note: This curve is test data of 1M LED Strip.

Light Distribution Curve [Unit: cd]

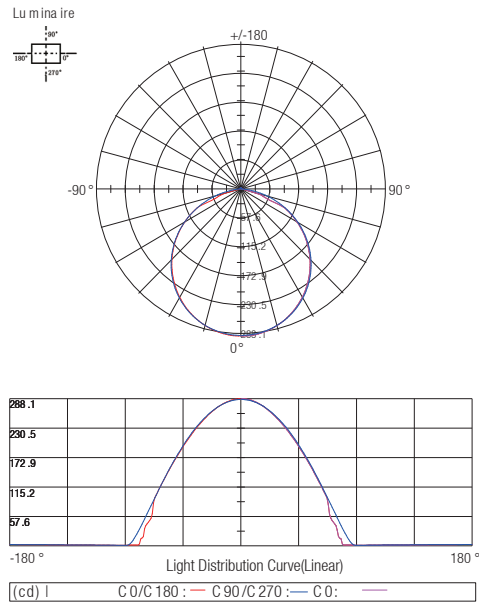

Lux–Distance Curve

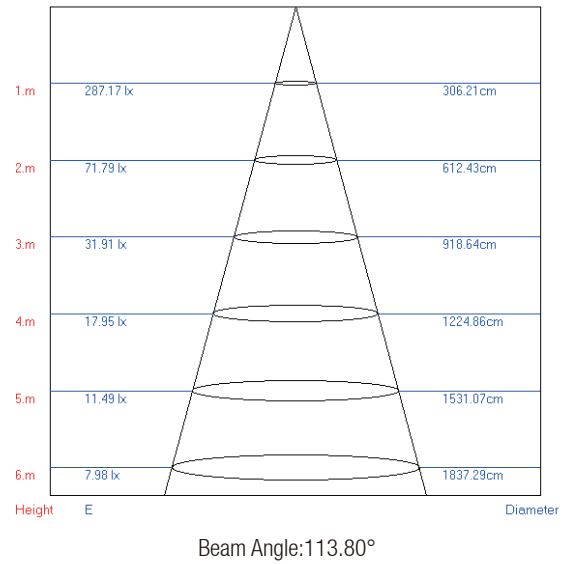

Installation Diagram

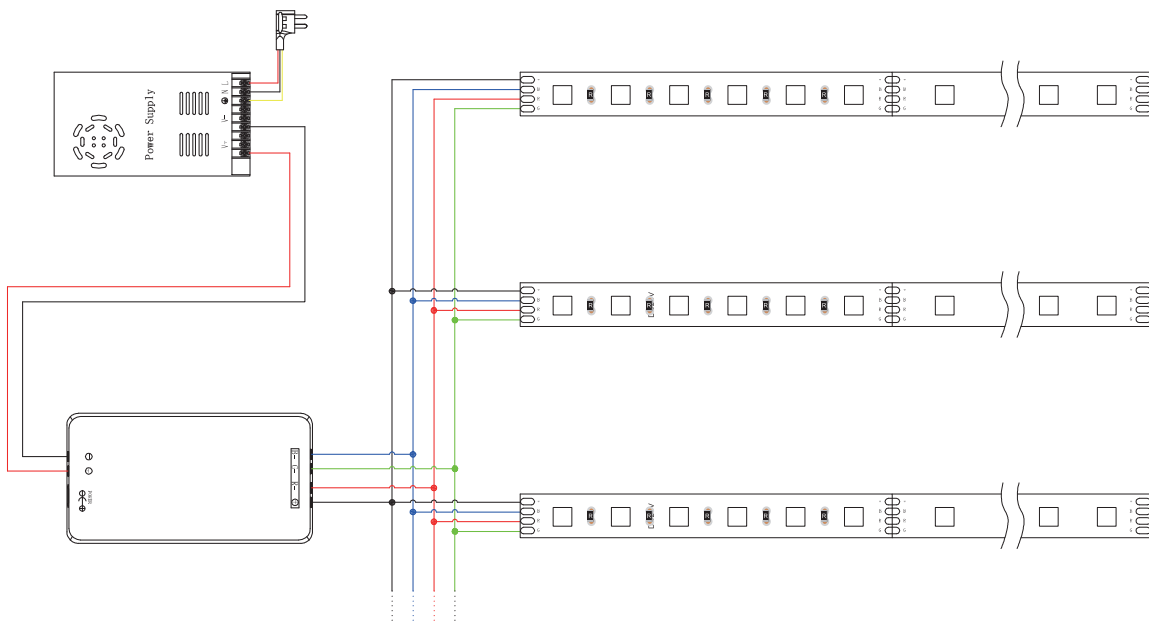

! Cautions

When install the led strip,please note the installation technique.The led strip can be bent,but not distorted,as shown below.

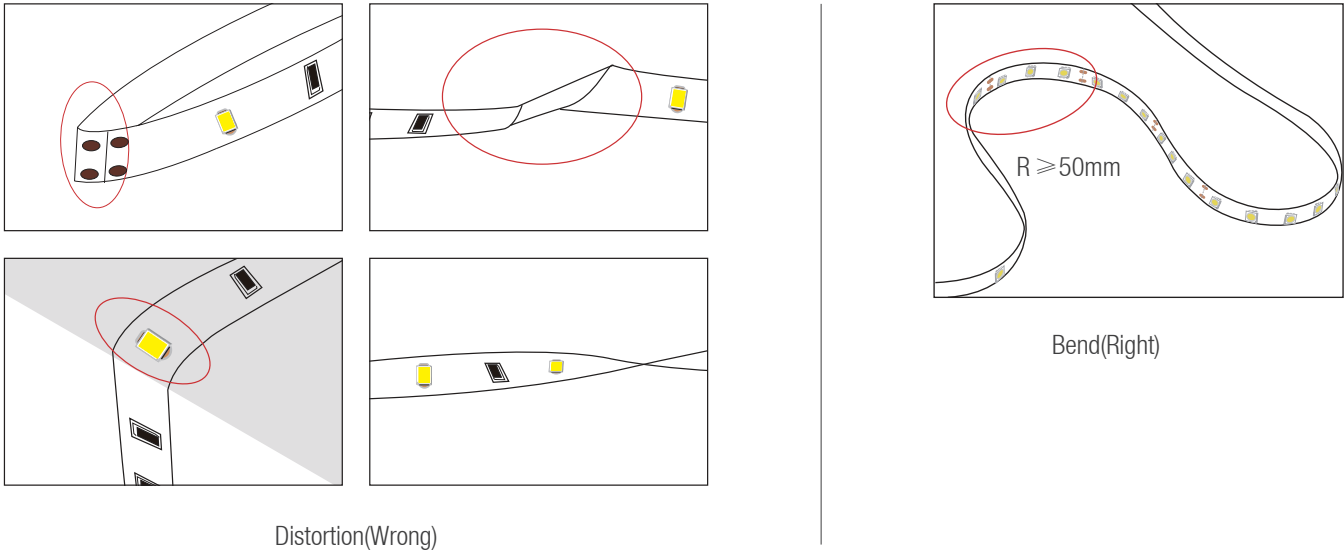

➤ LED strips are low voltage products,you must use the power supply(transformer).Please don,t connect the led strip directly to the AC 110v or AC 220v,otherwise it will burn out the LED strips.

➤ Clean up the installation surface,it will ensure the reliability of the adhesive,The electrical connection process must be operated by a professional person.

📦 Package

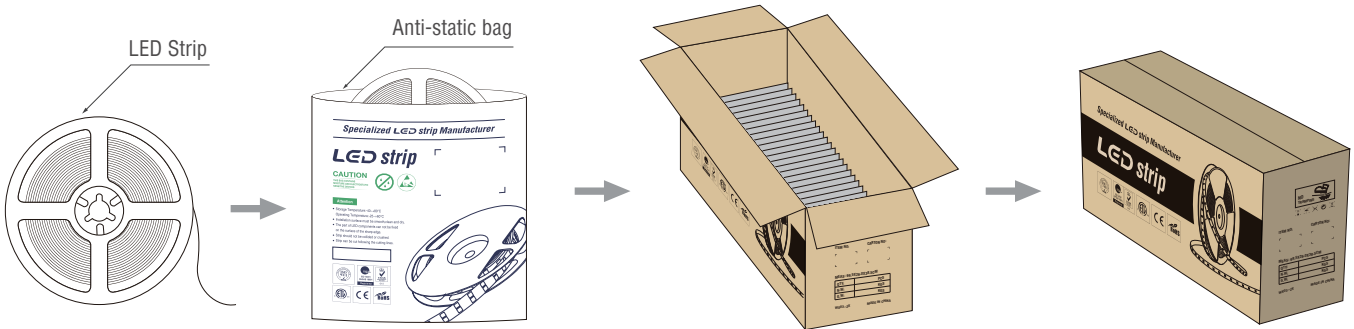

Certification

Certificate CN1730296

The management system of **SHENZHEN SHINESKY OPTOELECTRONICS CO., LTD.**

2F, H1 Building, Hongfa Hi-tech Park, Tangtou, Shiyuan Town, Baoan District, Shenzhen, Guangdong, P.R. China
 Unified Social Credit Code 91440300781958133A

has been assessed and certified as meeting the requirements of **ISO 9001:2015**

For the following activities:
Design and manufacture of LED strip products

Further certification regarding the scope of this certificate and the applicability of ISO 9001:2015 requirements may be obtained by consulting the registration body. This certificate is valid from 2 March 2017 until 1 March 2020 and remains valid subject to satisfactory surveillance audits. Recertification audit due a minimum of 60 days before the expiration date. Issue 1, Certified since 2 March 2017.

Authorized by:

SGS United Kingdom Ltd
 Premium Business Park, Elmham Post, Chester, CH5 3JX, UK
 +44 (0)1243 824881 +44 (0)1243 204892 www.sgs.com
 The certification information can be verified on the web site of Certification and Accreditation Administration of the People's Republic of China www.cca.gov.cn

SGS 9001 2015 1015
 Page 1 of 1

Intertek

AUTHORIZATION TO MARK

This authorizes the application of the Certification Mark(s) shown below to the models described in the Product(s) Covered section when made in accordance with the conditions set forth in the Certification Agreement and Listing Report. This authorization also applies to multiple lot/serial model(s) identified on the continuation page of the Listing Report. This document is the property of Intertek Testing Services and is not transferable. The certification mark(s) may be applied only at the location of the Party Authorized to Apply Mark.

Applicant: Shenzhen Shinesky Optoelectronic Co., LTD 2F, H1 Building, Hongfa Hi-tech Park, Tangtou, Shiyuan Town, Baoan District, Shenzhen, Guangdong	Manufacturer: Shenzhen Shinesky Optoelectronic Co., LTD 2F, H1 Building, Hongfa Hi-tech Park, Tangtou, Shiyuan Town, Baoan District, Shenzhen, Guangdong
Country: China Contact: Bao Wu Phone: +86-755-29518255 FAX: - Email: mail@skled.com	Country: China Contact: Bao Wu Phone: +86-755-29518255 FAX: - Email: mail@skled.com

Party Authorized To Apply Mark: Same as Manufacturer
Report Issuing Office: Intertek Testing Services Shanghai

Control Number: 50009056 Authorized by:

This document supersedes all previous Authorizations to Mark for the noted Report Number.

Intertek Testing Services NA Inc.
 545 East Algonquin Road, Arlington Heights, IL 60005
 Telephone 800-368-5857 or 847-435-8887 Fax 815-235-1872

Low Voltage Lighting Systems - UL 2108 (Revised: 2004/02/27 Ed. 1 Rev. 2014/02/24)
 General Requirements for Luminaires - CSA C22.2 No. 0-10 (revised: 1995/09/01 Ed. 1 (R2011), with Gen. Int. 1 - 1997, Gen. Int. 2 - 1998)

Product: Low voltage flexible LED strip
Models: SK-ST3Q0V12, others "X", "Y" and "Z" is any number, "2" is a letter or the combination of a letter and a number

ATM for Report 150300649SH4-001 Page 1 of 1 ATM Issued: 21-May-2015

SGS

Verification Report No. CANEG1706839702 Date: 17 May 2017 Page 1 of 14

SHENZHEN SHINESKY OPTOELECTRONICS CO., LTD
 2F, H1 BUILDING HONGFA HI-TECH PARK, TANGTOU, SHIYUAN TOWN, BAOAN DISTRICT, SHENZHEN CITY 518108 P.R. CHINA

Sample Name: Flexible LED Strip
SGS Job No.: CP17-00413 - GZ

Internal Reference No.: 2.2
Tested Basic Model No.: SK-ST3Q08V12
(P.O. No.): -
Tested Extended Model No.: SK-ST3Q08V12, SK-ST3Q08V24, SK-ST3Q08V48
(P.O. No.): -
Client Ref. Info.: See remark (4)

Date of Sample Received: 19 Apr 2017
Verification Period: 10 Apr 2017 - 17 May 2017
Verification Requested: With reference to RoHS Directive 2015/863/EU amending 2011/65/EU
Verification Method: Please refer to next page(s).
Verification Result: Please refer to next page(s).
Verification Conclusion: Based on the verification results of the submitted sample(s), the results of Lead, Mercury, Cadmium, Hexavalent chromium, Polybrominated diphenyls (PBBs), Polybrominated diphenyl ethers (PBDEs) do not exceed the limit as set by RoHS Directive (EU) 2015/863 amending Annex II to Directive 2011/65/EU. The test results are related only to the tested items. The report shall not be reproduced except in full without the written approval of the testing laboratory.

Note:

Signed for and behalf of SGS-CSTC Standards Technical Services Co., Ltd. Guangdong Branch

Jenny Liao
 Approved Signatory

nqa global assurance

This is to certify that the Environmental Management System of

CLIENTS NAME SHINESKY OPTOELECTRONICS
 ADDRESS 2F, H1 Building, Hongfa Hi-tech Park, Tangtou, Shiyuan Town, Baoan District, Shenzhen City 518108 P.R. China

applicable to **SCOPE Flexible LED Strip**

has been assessed and registered by NQA against the provisions of **ISO 14001:2004**

This registration is subject to the company maintaining an environmental management system, to the above standard, which will be monitored by NQA. To maintain the validity of this certificate, the periodic surveillance shall be monitored by certification body. Please consult the website: www.nqa.com.cn

Certificate Number: 150300649SH4-001

Head of NQA:

Date: 18 May 2017
 Valid Until: 18 May 2020

nqa global assurance

This is to certify that the Environmental Management System of

CLIENTS NAME SHINESKY OPTOELECTRONICS
 ADDRESS 2F, H1 Building, Hongfa Hi-tech Park, Tangtou, Shiyuan Town, Baoan District, Shenzhen City 518108 P.R. China

applicable to **SCOPE Flexible LED Strip**

has been assessed and registered by NQA against the provisions of **OHSAS 18001:2007**

This registration is subject to the company maintaining an environmental management system, to the above standard, which will be monitored by NQA. To maintain the validity of this certificate, the periodic surveillance shall be monitored by certification body. Please consult the website: www.nqa.com.cn

Certificate Number: 150300649SH4-001

Head of NQA:

Date: 18 May 2017
 Valid Until: 18 May 2020

CERTIFICATE of Conformity
 EC Council Directive 2014/30/EU
 Electromagnetic Compatibility

Registration No.: AE 50378145 0001
 Report No.: 50080521 001

Holder: ShenZhen Shinesky Optoelectronics Co., Ltd
 2F, H1 Building, Hongfa Hi-tech Park, Tangtou, Shiyuan Town, Baoan District, Shenzhen City 518108 P.R. China

Product: LED-Fluorescence (Flexible LED Strip)

Identification: Type Declaration No.: SR-ST3Q07V24 (to refer to test report)
 Serial No.: 0104
 Remark: Refer to above-listed test report for details.

Tested acc. to: EN 55015:2013
 EN 61547:2009

This certificate of conformity is based on an evaluation of a sample of the above mentioned product. Technical Report and documentation are at the License Holder's disposal. This is to certify that the tested sample is in conformity with all provisions of Annex III of Council Directive 2014/30/EU. This certificate does not imply assessment of the production of the product and does not permit the use of a TÜV Rheinland mark of conformity. The holder of the certificate is authorized to use this certificate in connection with the EC declaration of conformity according to the a.m. Directives.

Certification Body:

Date: 16.05.2017

TÜV Rheinland LGA Products GmbH · Tinseltalweg 2 · 90431 Nürnberg

CE The CE marking may only be used if all relevant and effective EC Directives are complied with CE

S H I N E S K Y

**Specialized
LED strip
Manufacturer**

SHENZHEN SHINESKY OPTOELECTRONICS CO.,LTD



Building 29, Shancheng Industrial Park, Shiyan Street, Bao'an District,
Shenzhen, Guangdong, China.



OUR EMAIL

director@shineskygroup.com



OUR PHONE

Tel: 0755-29516255



OUR WEBSITE

www.strip-lights.com